

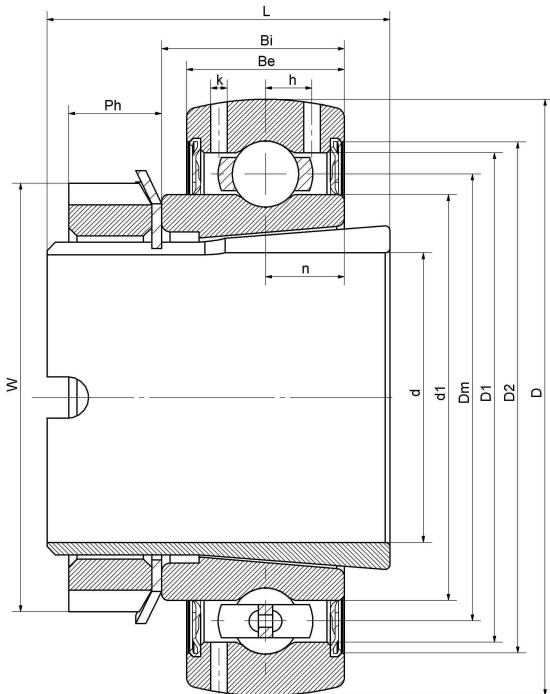

## UH 209/30 2T.SH

Agricultural machinery bearings

### 技术信息



#### 主要尺寸和性能参数

d1	30mm	Bore diameter
D	85mm	Outside diameter
W	52mm	KM nut outside diameter
D2	57mm	MB Washer outside diameter
B1	35mm	Width adapter sleeve
C	23mm	Width outer ring
L	8mm	KM nut width
M	35x1.5	Thread adapter sleeve
≈m	0.7Kg	weight
Cor	33.2Kn	Radial dynamic load rating
Cr	21.6Kn	Radial static load rating
Pu	0.91Kn	Fatigue load limit

\*数据表仅为所选产品的尺寸和基本额定载荷概览。请始终遵守本产品的所有更多信息和指南。您可通过我们网站上的联系表了解更多信息。

联系方式: 邮箱: [mr.suo@zrbearing.net](mailto:mr.suo@zrbearing.net)

电话: 0319-5628888

地址: 河北省临西县城北环路北侧-中达轴承