

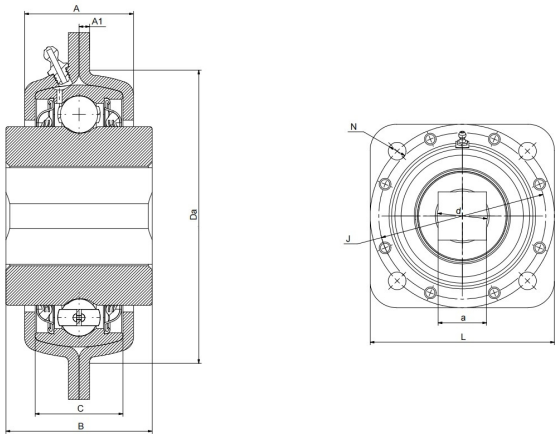

## GWST 209PPB28

Agricultural machinery bearings

### 技术信息



#### 主要尺寸和性能参数

d1	46.831mm	Bore diameter
B	42.85mm	Width inner ring
C	22mm	Width outer ring
Da	97mm	Centering diameter
L	127mm	Overall length
A	39mm	Distance from the housing flange to the front of the inner ring of the bearing
A1	3.5mm	Width of the top of the housing
J	登录可见尺寸, 去登录	Pitch circle diameter
N	13.5mm	Diameter of attachment slot
Fr	7.7Kn	Radial load
Fa	3.8Kn	Axial load
≈m	1.69Kg	weight
Cor	32.5Kn	Radial dynamic load rating
Cr	20.4Kn	Radial static load rating

\*数据表仅为所选产品的尺寸和基本额定载荷概览。请始终遵守本产品的所有更多信息和指南。您可通过我们网站上的联系表了解更多信息。