

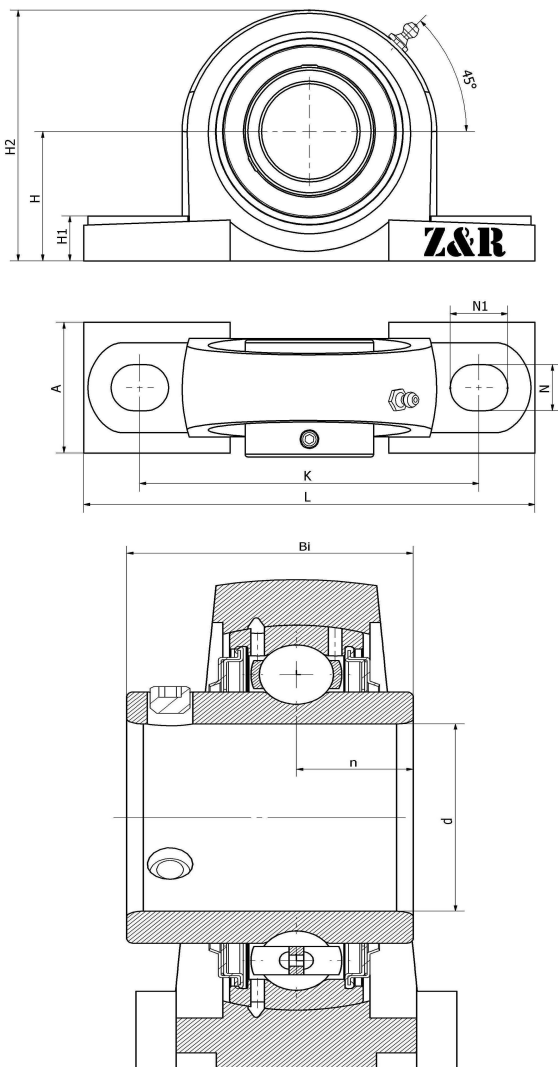

## UCP 206-20 F

Plummer block housing unit P type, Cast iron housing, Set screw locking spherical ball bearing, F type seal

### 技术信息



### 主要尺寸和性能参数

d	31.75mm	Inside diameter
H	42.9mm	Center height
H1	17mm	Base height
H2	84mm	Overall height
A	44mm	Base width
N	17mm	Mounting hole length
N1	23mm	Mounting hole width
L	160mm	Overall length
K	121mm	Fixed hole distance
Bi	38.1mm	Total width
n	15.9mm	channel distance
	M14	Bolt size
≈m	0.19Kg	weight
	UC206-20	Bearing Type
	P206-20	Bearing seat model
	M6*1	Oil injection hole
	J6	Assembly torque
	HT200	Bearing seat material

\*数据表仅为所选产品的尺寸和基本额定载荷概览。请始终遵守本产品的所有更多信息和指南。您可通过我们网站上的联系表了解更多信息。