

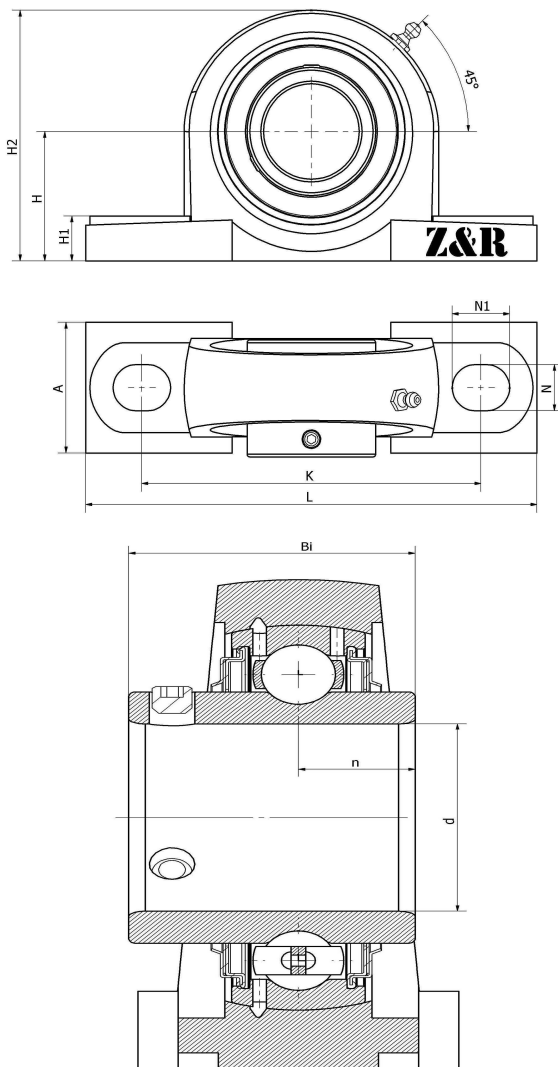

UCP 207 F

Plummer block housing unit P type, Cast iron housing, Set screw locking spherical ball bearing, F type seal

技术信息



主要尺寸和性能参数

d	35mm	Inside diameter
H	47.6mm	Center height
H1	17mm	Base height
H2	93mm	Overall height
A	48mm	Base width
N	17mm	Mounting hole length
N1	23mm	Mounting hole width
L	167mm	Overall length
K	127mm	Fixed hole distance
Bi	42.9mm	Total width
n	17.5mm	channel distance
	M14	Bolt size
≈m	1.3Kg	weight
	UC207	Bearing Type
	P207	Bearing seat model
	M6*1	Oil injection hole
	J6	Assembly torque
	HT200	Bearing seat material

*数据表仅为所选产品的尺寸和基本额定载荷概览。请始终遵守本产品的所有更多信息和指南。您可通过我们网站上的联系表了解更多信息。