

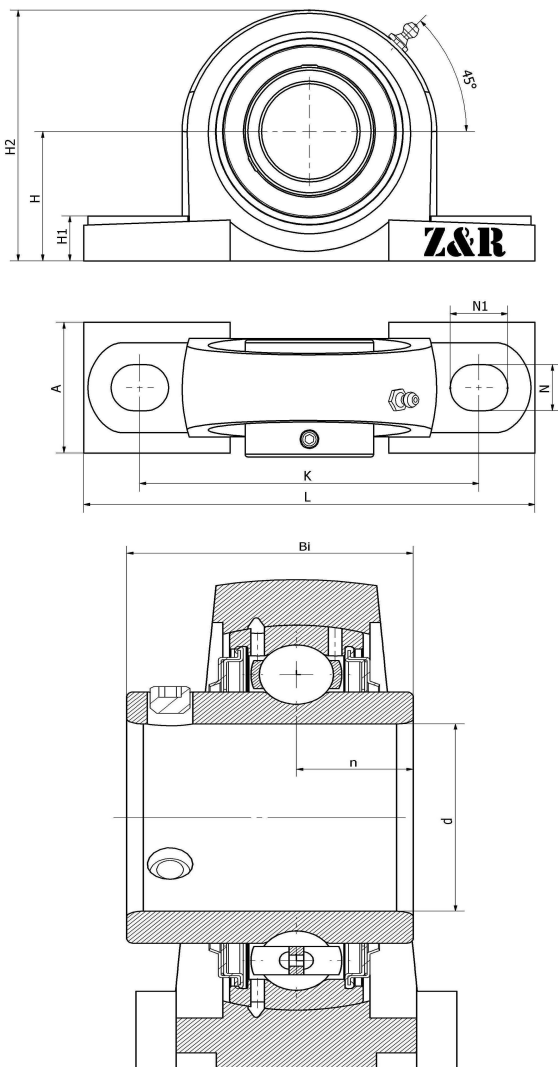

## UCP 311-32 F

Plummer block housing unit P type, Cast iron housing, Set screw locking spherical ball bearing, F type seal

### 技术信息



#### 主要尺寸和性能参数

d	50.8mm	Inside diameter
H	80mm	Center height
H1	30mm	Base height
H2	154mm	Overall height
A	80mm	Base width
N	20mm	Mounting hole length
N1	38mm	Mounting hole width
L	310mm	Overall length
K	236mm	Fixed hole distance
Bi	66mm	Total width
n	25mm	channel distance
	M16	Bolt size
≈m	7.42Kg	weight
	UC311-32	Bearing Type
	P311-32	Bearing seat model
	M6*1	Oil injection hole
	J6	Assembly torque
	HT200	Bearing seat material

\*数据表仅为所选产品的尺寸和基本额定载荷概览。请始终遵守本产品的所有更多信息和指南。您可通过我们网站上的联系表了解更多信息。