

### GSH 30/V2--SAF

Insert spherical bearings, eccentric sleeve locked outer spherical bearings, three-layer sealed outer spherical bearings

## 技术信息

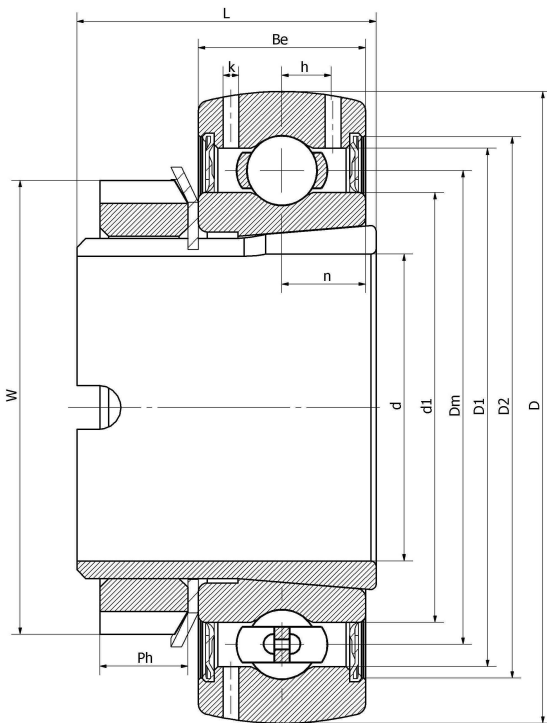

### 主要尺寸和性能参数

d	30mm	Inside diameter
D	62mm	Outside diameter
W	45mm	Eccentric sleeve outer diameter
Be	18mm	Outer ring height
h	4.7mm	Oil hole distance
n	9mm	channel distance
L	32mm	total height
Ph	14mm	Eccentric sleeve height
Cr	18900N	Radial static load rating
Cor	11300N	Radial dynamic load rating
Pu	600N	Fatigue load limit
≈m	0.28Kg	weight

\*数据表仅为所选产品的尺寸和基本额定载荷概览。请始终遵守本产品的所有更多信息和指南。您可通过我们网站上的联系表了解更多信息。