



UK 212/V2/--F

Insert bearings, eccentric sleeve locked outer spherical bearings, three-layer sealed outer spherical bearings

YSA212/V2/--F

技术信息

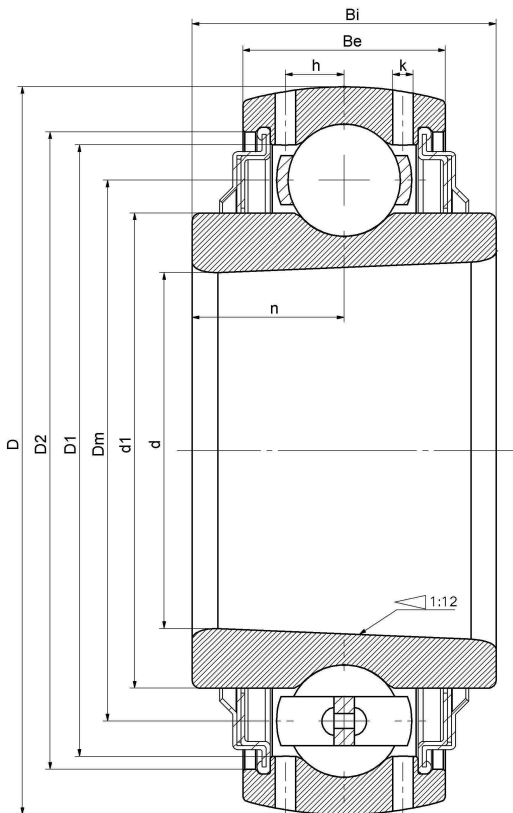

主要尺寸和性能参数

d	55mm	Inside diameter
D	110mm	Outside diameter
d1	登录可见尺寸, 去登录	Outer diameter innering
Dm	85mm	Center diameter
D1	登录可见尺寸, 去登录	Outer ring inner diameter
D2	登录可见尺寸, 去登录	Seal groove diameter
Be	27mm	Outer ring height
h	8.2mm	Oil hole distance
k	1.8mm	Oil hole diameter
n	18mm	channel distance
Bi	36mm	Inner ring height
Cr	52500N	Radial static load rating
Cor	22000N	Radial dynamic load rating
≈m	1.45Kg	weight

*数据表仅为所选产品的尺寸和基本额定载荷概览。请始终遵守本产品的所有更多信息和指南。您可通过我们网站上的联系表了解更多信息。